

Article number: 2310307541ESD

Description: E+G Antistatic base for levelling elements
LV.A-60-14-AS-M16x148-ESD-C

Measures

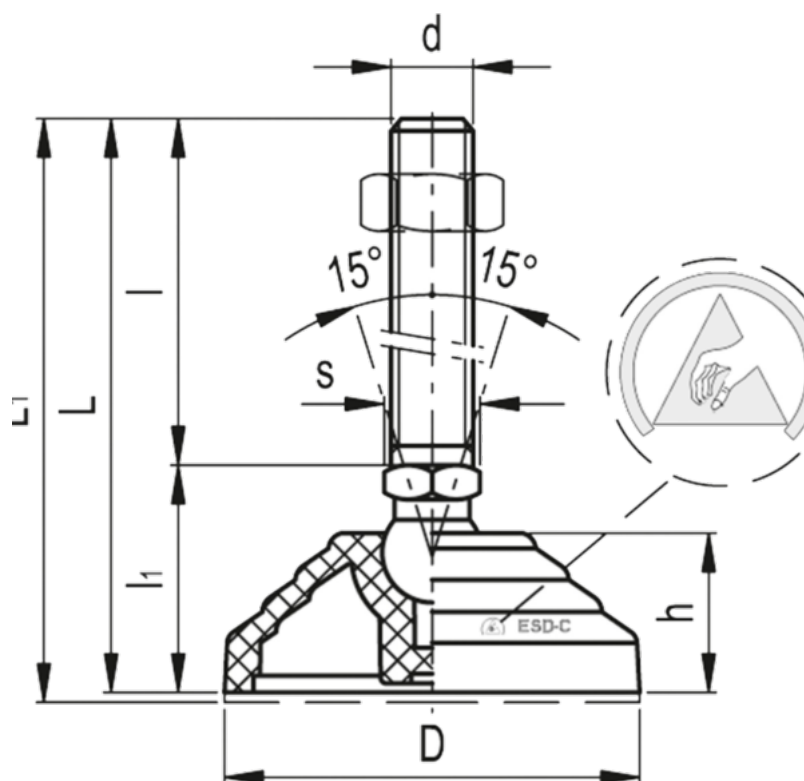

Articulation = 14	Max load = 14000
D = 60	s = 16
d = M16	Weight in (g) = 265
h = 24	
l = 148	
l1 = 33	
L = 181	
L1 = 184	